

Full Length Research Paper

Regulation of the electric power provided by the panels of the photovoltaic systems

M. El Ouariachi¹, T. Mrabti¹, B. Tidhaf², Ka. Kassmi¹ and K. Kassmi^{1*}

¹University Mohamed First, Faculty of Science, dept of Physics, LEPAS, Oujda, Morocco.

²University Mohamed First, ENSA, Oujda, Morocco.

Accepted 22 May, 2009

In this paper we analyzed in Pspice the influences of the solar radiation and the temperature on the optimal operation of the photovoltaic (PV) panels and the PV systems provided with an MPPT command (CFV) which fixes a voltage (V_{opt}) at output of PV panel. We have shown that the V_{opt} voltage depends on the seasons and function of the temperature. Between winter and summer the variation can reach 1V. This variation can induce losses of powers higher than 30%. From the measurements taken during days when the solar radiation can reach 900 W/m^2 in midday and of the results of optimization of the panels functioning in Pspice simulator, we have showed that MPPT command carries out its role correctly if the value of the fixed V_{opt} voltage is the optimal value of the panel in the midday. By taking account of this condition we have showed, lasting all the day, that MPPT command optimizes power provided by the panels and that the losses of powers are lower than 2%.

Key words: Photovoltaic panels, photovoltaic systems, maximum power point tracking (MPPT)- MPPT command, influence of the solar radiation and the temperature optimal voltage of the panels.

INTRODUCTION

Currently, the sources of energy and the harmful increase in the greenhouse effect are topical urged. They pushed the scientists to have recourse to new renewable energies, non polluting. Among these energies one finds the energy photovoltaic (PV) (Woyte et al. 2006; Mohamed, 2002) whose electrical energy is produced by PV panels (Mrabti et al., 2009; Kassmi et al., 2007; Mrabti et al., 2008; Salameh et al., 1991; Kottas et al., 2006; Gruber et al., 2005; Salameh and Taylor 1990). PV energy has also found its utility in small scale applications and for isolated systems of transformations (Woyte et al., 2006). Photovoltaic energy is a source of inexhaustible and non polluting renewable energy source (Mrabti et al., 2009). The main issue of the production of electrical energy by this technique is the optimal operation of the panels (modules) photovoltaic (Mohamed, 2002; Mrabti et al., 2009; Kassmi et al., 2007; Mrabti et al., 2008; Salameh et al., 1991; Kottas et al., 2006; Gruber et al., 2005; Salameh and Taylor 1990). This can reduce in a considerable way, the cost of PV installation and increase

the output of PV generators.

Currently, many researches are carried out on the design of the MPPT command which optimize the electric output provided by the PV panels (Jain and Agarwal, 2004; Gules et al., 2008; ESRAM et al., 2006; Al-Atrash et al., 2005). One found numerical MPPT commands (Bahgat et al., 2005; Femia et al., 2004; Taftcht et al., 2008; Yu et al., 2004), which require the use of the microcontrollers and the algorithms of data processing (Jain and Agarwal, 2004) and of the analogical command (Mohamed, 2002; Mrabti et al., 2009; Kassmi et al., 2007; Mrabti et al., 2008; Salameh et al., 1991; Kottas et al., 2006; Gruber et al., 2005; Salameh and Taylor 1990), which use electronic and digital components. The analogical commands are characterized by the simplicity of realizations, lower low cost and can function at high frequencies. In the case of that last command and since the optimal voltage of PV panels varies very little with solar irradiation and the temperature, in the literature (Salameh et al., 1991; Kottas et al., 2006; Gruber et al., 2005; Salameh and Taylor, 1990; Jain and Agarwal, 2004; Gules et al., 2008; ESRAM et al., 2006), one finds simple commands which fix the voltage of PV panels at a fixed value (command CFV). This command is less

*Corresponding author. E-mail: khkassmi@yahoo.fr.

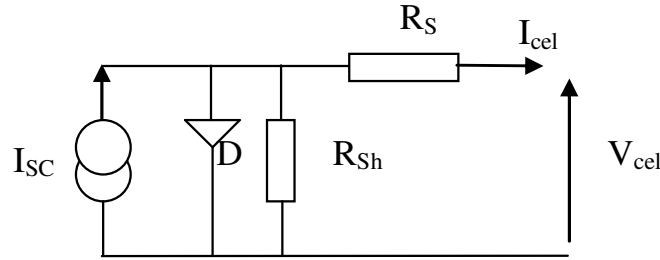

Figure 1. Electric diagram of a PV cell.

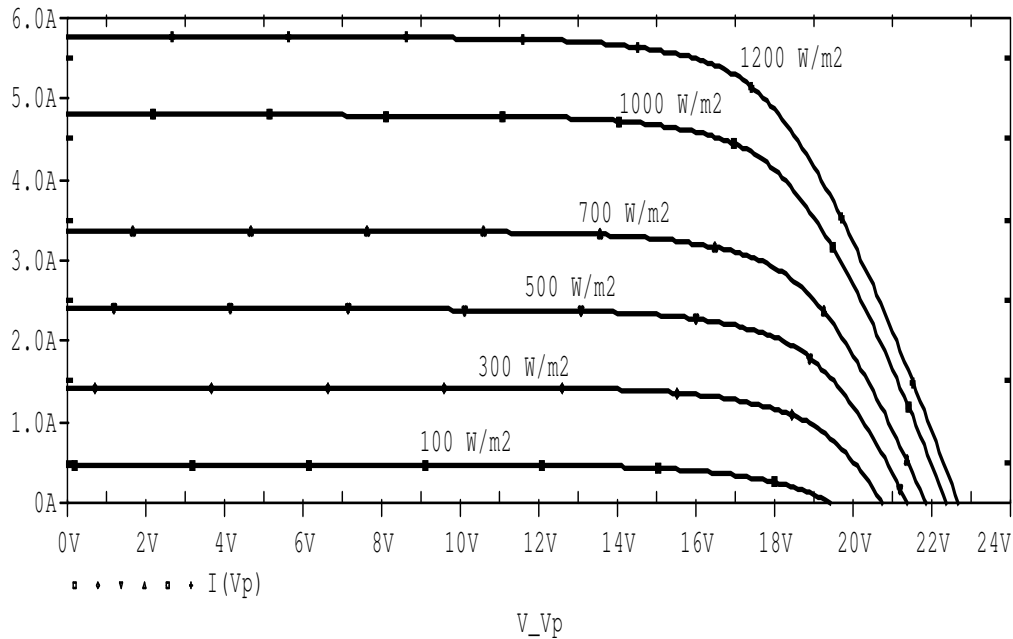

Figure 2. Simulation of the characteristics current-voltage of module SP75 as a function of solar radiation at the temperature 25°C.

expensive and the time of convergence of PV panels at the maximum power point (PPM) is fixed by the response time of the analogical and digital components of the command (of the order of milliseconds). Actually, during one day the temperature variations are enormous and can affect the optimal voltage of PV panels. Moreover, on the level of the PV panel, the temperature can reach a very important value: higher than 40°C. Therefore, the use of MPPT command CFV can induce losses of electrical power. Consequently, the analysis of the electric operation of PV panel as well as the PV systems provided MPPT command CFV as a function of the temperature is essential.

In this Work, we have analyzed in Pspice the optimal electric operation of PV modules SP 75 as a function of solar radiation and of the temperature. Based on the obtained results, we characterized and modeled the electric properties of PV panels SP75 installed at the laboratory. By taking account of the obtained results we have

analyzed experimentally the operation of the PV system provided with CFV command. A particular intention will be attached to the analysis of the regulation of the command as a function of the voltage fixed by MPPT command during one day.

Analysis photovoltaic panels in Pspice

Electric characteristic of the module SP 75

We have symbolized in Pspice simulator the electric diagram of the PV panel SP 75 which is made of 36 cells in series (Figure 1) (Mrabti et al., 2009; Kassmi et al., 2007; Mrabti et al., 2008; Sze, 1981). As shown in the Figure 1, a PV cell is formed by the short-circuit current (I_{sc}), the diode (D), the shunt resistance (R_{sh}) and series resistance (R_s). From the comparison of the results of simulations and those provided by the manufacturer we deduced the various parameters from the diode and those of PV cell:

- i) Series resistance: $R_s = 12.5 \text{ m}\Omega$,
- ii) Shunt resistance: $R_{sh} = 1 \text{ M}\Omega$,

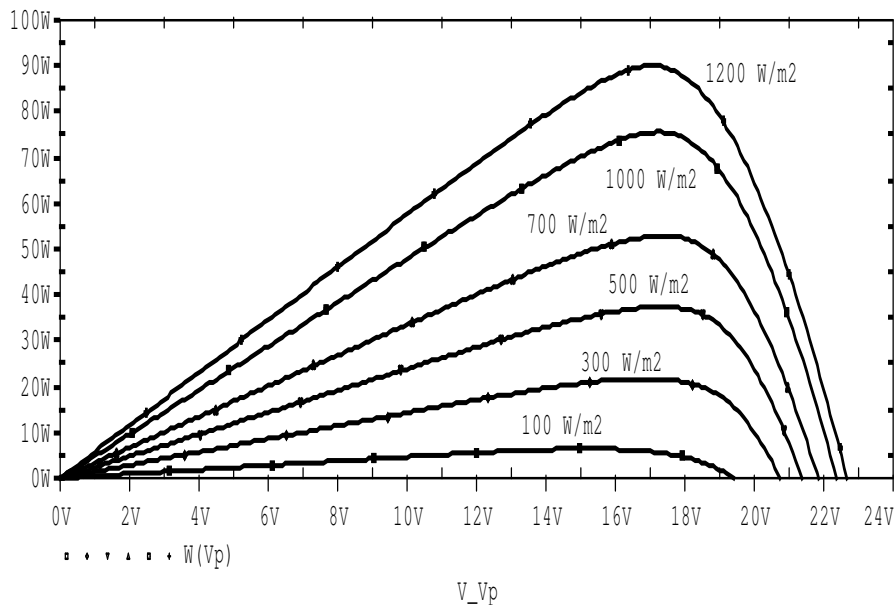

Figure 3. Simulation of the characteristics power-voltage of module SP75 as a function of solar radiation at the temperature 25°C.

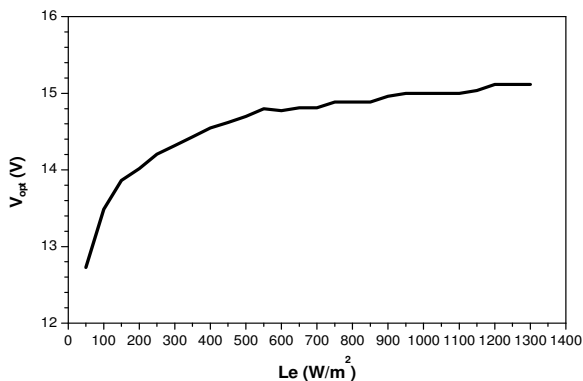

Figure 4. Simulation of the influence of solar radiation on the Vopt voltage of module SP75 at the temperature 25°C.

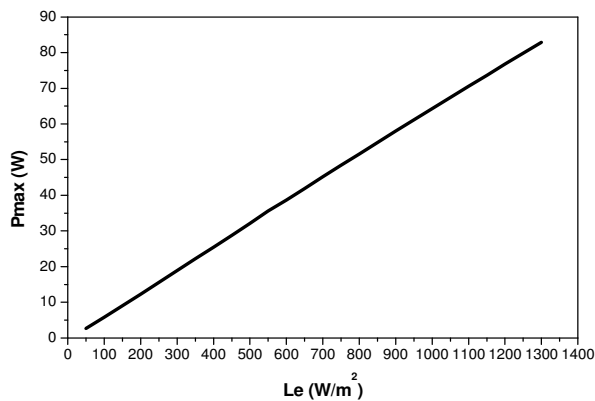

Figure 6. Simulation of the influence of solar radiation on the Pmax power of module SP75 at the temperature 25°C.

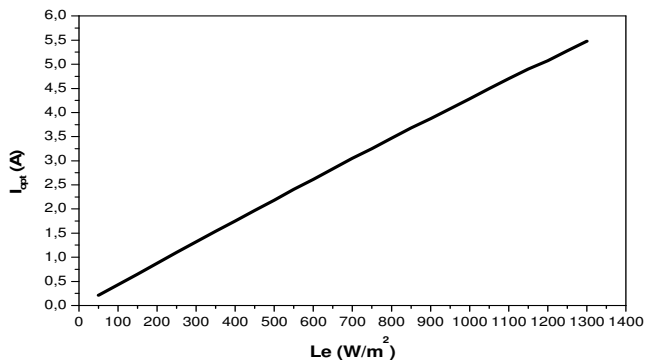

Figure 5. Simulation of the influence of solar radiation on the Iopt current of module SP75 at the temperature 25°C

iii) Dependence of the short-circuit current (I_{sc}) with solar radiation [$Le (W/m^2)$]:

$$I_{sc} = 0.00481 * Le - 0.0125 \tag{1}$$

On Figures 2 and 3 we have represented the typical characteristics current-voltage and power-voltage as a function of solar radiation for a temperature of 25°C. It appears that the power provided by PV panel is maximum (Pmax) for an optimal current Iopt and voltage Vopt. From the characteristics of Figure 2, we have deduced the optimal characteristics (Vopt, Iopt and Pmax) from module SP75 as a function of solar radiation. The results obtained are represented on Figures 4 to 6. It appears that for strong solar radiation, the optimal voltage Vopt depends very little on solar

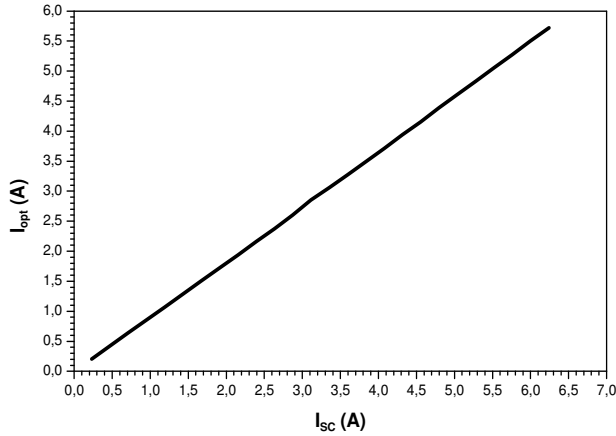

Figure 7. Evolution of the I_{opt} current as a function of current I_{sc} at the temperature 25°C.

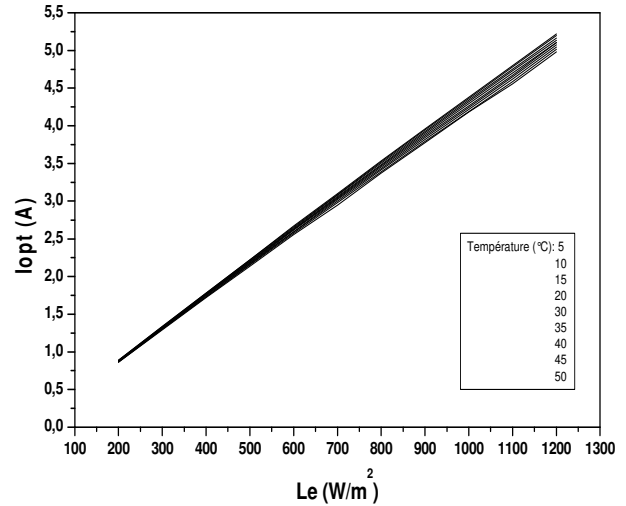

Figure 9. Simulation of the influence of the temperature and solar radiation on the optimal I_{opt} current.

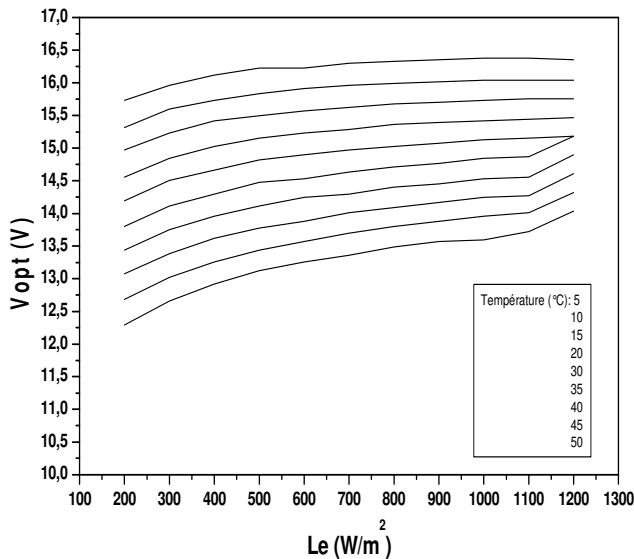

Figure 8. Simulation of the influence of the temperature and solar radiation on the optimal V_{opt} voltage

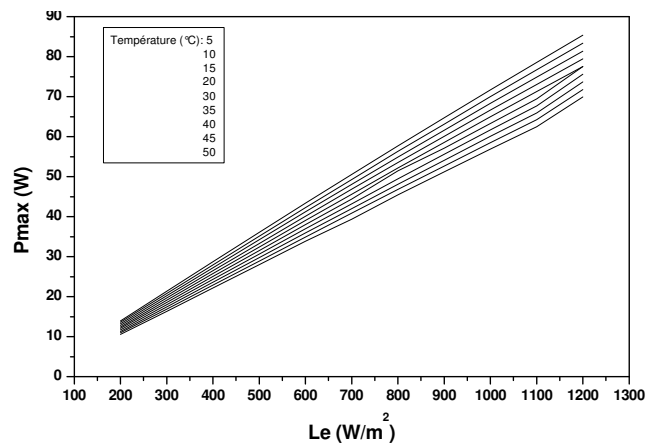

Figure 10. Simulation of the influence of the temperature and solar radiation on the optimum P_{max} power in Pspice.

radiation and it is in the order of 15 V.

Also, we have traced on Figure 7 the evolution of the optimal current (I_{opt}) as a function of the short-circuit current (I_{sc}). It appears a linear behavior following the relation:

$$I_{opt} = 0.06214 + 0.87862 * I_{sc} \tag{2}$$

The equation 1 and 2 show that the measurement of the short-circuit current makes it possible to deduce the value of the solar radiation (Le) and the optimal current (I_{opt}) of PV panel.

Influence of the temperature on the optimal electrical characteristics of module SP 75

From the Pspice simulator, we have traced the various characteris-

tics power-voltage as a function of solar radiation and temperature, then we have deduced the optimal voltage (V_{opt}), the optimal current (I_{opt}) and the optimum power (P_{max}) as a function of solar radiation (Figures 8 to 10). It appears that:

- i) The optimal current decreases with temperature. For a solar radiation of 1000 W/m^2 , when the temperature increases (decreases) by 20°C around the ambient temperature (25°C) the current decreases (increases) by 2.5% (2%).
- ii) The optimal voltage (V_{opt}) decreases with temperature. For a solar radiation of 1000 W/m^2 , when the temperature increases (decreases) by 20°C around the ambient temperature (25°C) the V_{opt} voltage decreases (increases) by 8% (8.3%).
- iii) The maximum power (P_{max}) decreases with the temperature in particular for a strong solar radiation (higher than 600 W/m^2). For a solar radiation of 1000 W/m^2 , when the temperature increases (decreases) by 20°C around the ambient temperature (25°C) the P_{max} power decreases by 10% (10.4%).

The whole of the results obtained show that the temperature degrades the electric quantities of PV panels. The optimal voltage of the panel depends very little on solar radiation for a given

Table 1. Optimal V_{opt} voltage as a function of the temperature for solar radiation of 1000 W/m^2 .

T (°C)	0	5	15	25	35	45
V_{opt} (V)	16.680	16.360	15.76	15.120	14.531	13.958

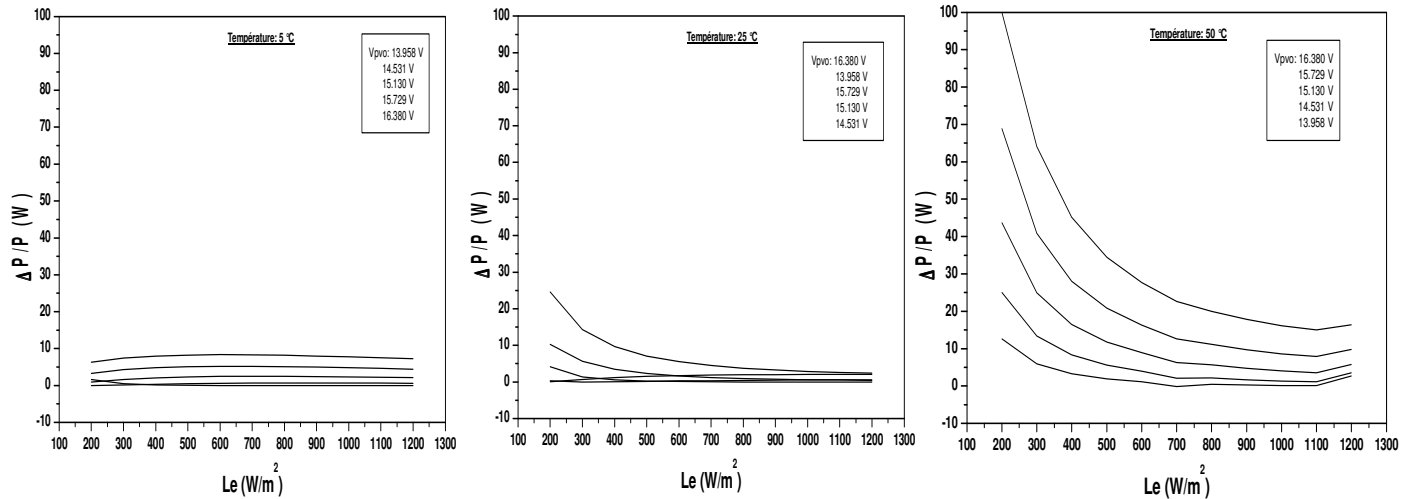

Figure 11. Relative variation of the power provided from the PV panel, compared to the optimum one, by setting the voltage of table 1 as a function of the solar radiation and the temperature.

temperature. Since during one day the temperature undergoes important variations, in particular around PV panels, then the optimal voltage varies in a considerable way. If the MPPT command used, for the regulation of the power provided by PV panels, which is that which sets a voltage 'CFV', the variations of the temperature can limit in a considerable way the electric performances of these PV panels.

On Table 1, we have represented the values of the optimal voltage V_{opt} for several temperatures with a solar radiation of 1.000 W/m^2 . These values show that during the operation of PV system, it is expect necessary to envisage during the day a variation of the optimal voltage of 1 V for the cold seasons (winter) and hot (summer). Therefore, the voltage fixed by the command must be readjusted according of the seasons.

On Figure 11 we have represented the influence of solar radiation on the relative variation of the power provided by PV panel, compared to the optimal conditions, as a function of the V_{pvo} voltage of the panel for 3 temperatures. It appears that the relative variation strongly depends on the temperature and the V_{pvo} voltage must be chosen as a function of the temperature. Also, we can deduce:

- i) During the cold season, when the temperature is around of 5°C , by setting the V_{pvo} voltage (15 V), corresponding to the temperature 25°C , the powers losses are lower than 2.5% independently of the solar radiation intensity.
- ii) During the hot seasons, when the temperature is around in order of 50°C , by setting the V_{pvo} voltage (15 V) corresponding to the temperature 25°C , the powers losses are lower than 4.8% independently of the solar radiation intensity.
- iii) During the seasons when the temperature is around of the order 25°C , by setting the V_{pvo} voltage (16 V) corresponding to that of

the cold season (5°C), the power losses are lower than 2% independently of solar radiation intensity.

The whole of the results obtained enable us to conclude that the power losses of PV panels can be due to the increase in the temperature and the choices of the V_{pvo} voltage set by MPPT command CFV. Also, the power losses due to the increase of the temperature are very important compared to those due to the V_{pvo} voltage if the latter undergoes variations of 1 V.

We have analyzed the influence of the V_{pvo} voltage of MPPT command CFV on the total operation of the system designed in Pspice and realized at the laboratory.

Electric characterization of the PV panels

The PV panels SP75 which were the subject of our experimental study are represented on Figure 12. A panel consists of 36 single-crystal cells and can provide under the standard conditions of test (solar radiation of 1000 W/m^2 , temperature of 25°C , spectrum AM1.5) a peak power of 75 W and a current of 4.41 A under a voltage 17 V. These panels and conceived PV systems are characterized from the measuring equipments developed at the laboratory (Figure 13). We have characterized the module SP 75 during one day when the intensity of solar radiation is around of 701 W/m^2 and the temperature of 25°C . On Figures 14 and 15 we have represented the typical characteristics current-voltage and power-voltage obtained. On the same Figures we



Figure 12. Photovoltaic panels SP75 installed in laboratory.



Figure 13. The measuring equipments allowing the characterisation of the panels and photovoltaic systems.

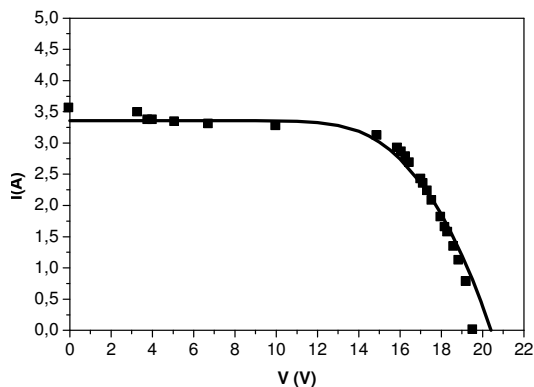

Figure 14. Characteristics current-voltage experimental (■) and simulated in Pspice (—). 20 January 2007. T : 25°C, $Le = 701 \text{ W/m}^2$.

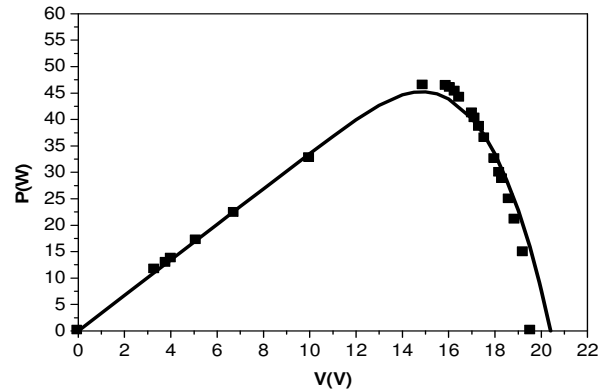

Figure 15. Characteristics power-voltage experimental (■) and simulated in Pspice (—). 20 January 2007. T : 25°C, $Le = 701 \text{ W/m}^2$.

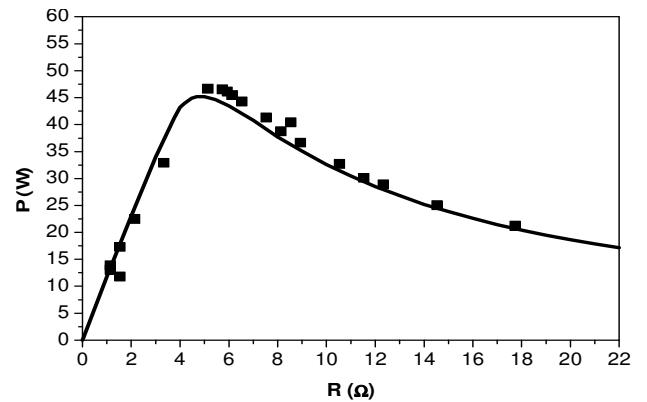

Figure 16. Characteristics power-resistance experimental (■) and simulated in Pspice (—). 20 January 2007. T : 25°C, $Le = 701 \text{ W/m}^2$.

have represented the characteristics simulated in Pspice by taking account of the parameters set during the symbolization of the module SP75. The comparison between the 2 characteristics enables us to deduce a very good agreement between the experiment and simulation. The same Figures 14 and 15 show that the maximum power provided by the generator is around of 48 W.

On Figure 16 we have represented the theoretical influence (Pspice) and experimental of resistance, connected to the output of the panel on the PV panel power. It appears on the one hand a good agreement between the experiment and simulation and on the other hand that the optimal resistance of PV panel is around of the order of 5 Ω. In PV applications, the value of the load is never set by the user and consequently PV panels never function under the optimal conditions. Therefore, the use of MPPT command is essential in order to optimize the operation of PV panels.

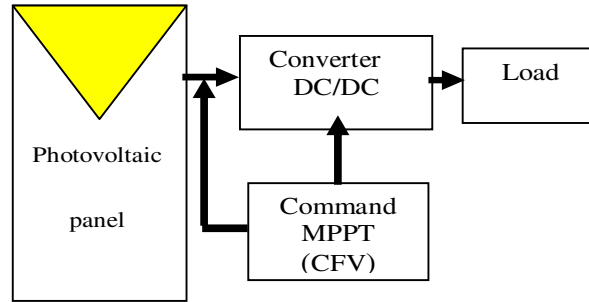

Figure 17. Synoptic diagram of PV system adapted by a DC-DC converter and an MPPT command.

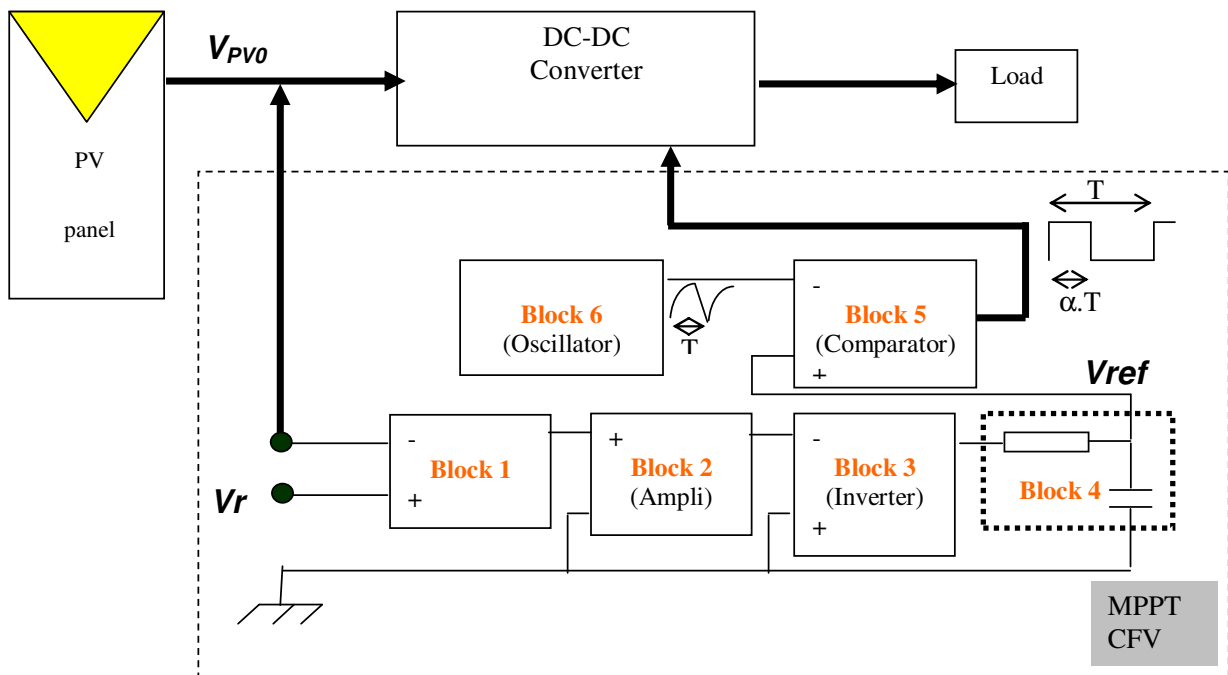

Figure 18. Photovoltaic system provided with an MPPT command CFV.

Photovoltaic system provided with MPPT command CFV

Structure of PV system

The synoptic diagram of a PV system is represented on Figure 17. This system is formed by:

- i) A PV panel (SP75).
- ii) DC-DC converter (Boost), dimensioned to function at the frequency of 10 kHz.
- iii) The MPPT command CFV, which has as a role to set a voltage V_{pv0} at the output of the panel.
- iv) A load (resistor of 50 Ω).

In order to reduce the PV cost of the installations of the photovoltaic systems, we chose to analyze thoroughly the MPPT command CFV since it is characterized by the simplicity of its realization, convergence towards the almost instantaneous maximum power point (MPP) (a few ms) and the relatively low cost. The various blocks of this command (Figure 18) are:

- i) The amplifier of difference (Block 1), which calculates and amplifies the difference between a PV panel voltage and a reference one (V_r).
- ii) Non-reverser amplifier (Block 2), which has as a role to amplify the difference.

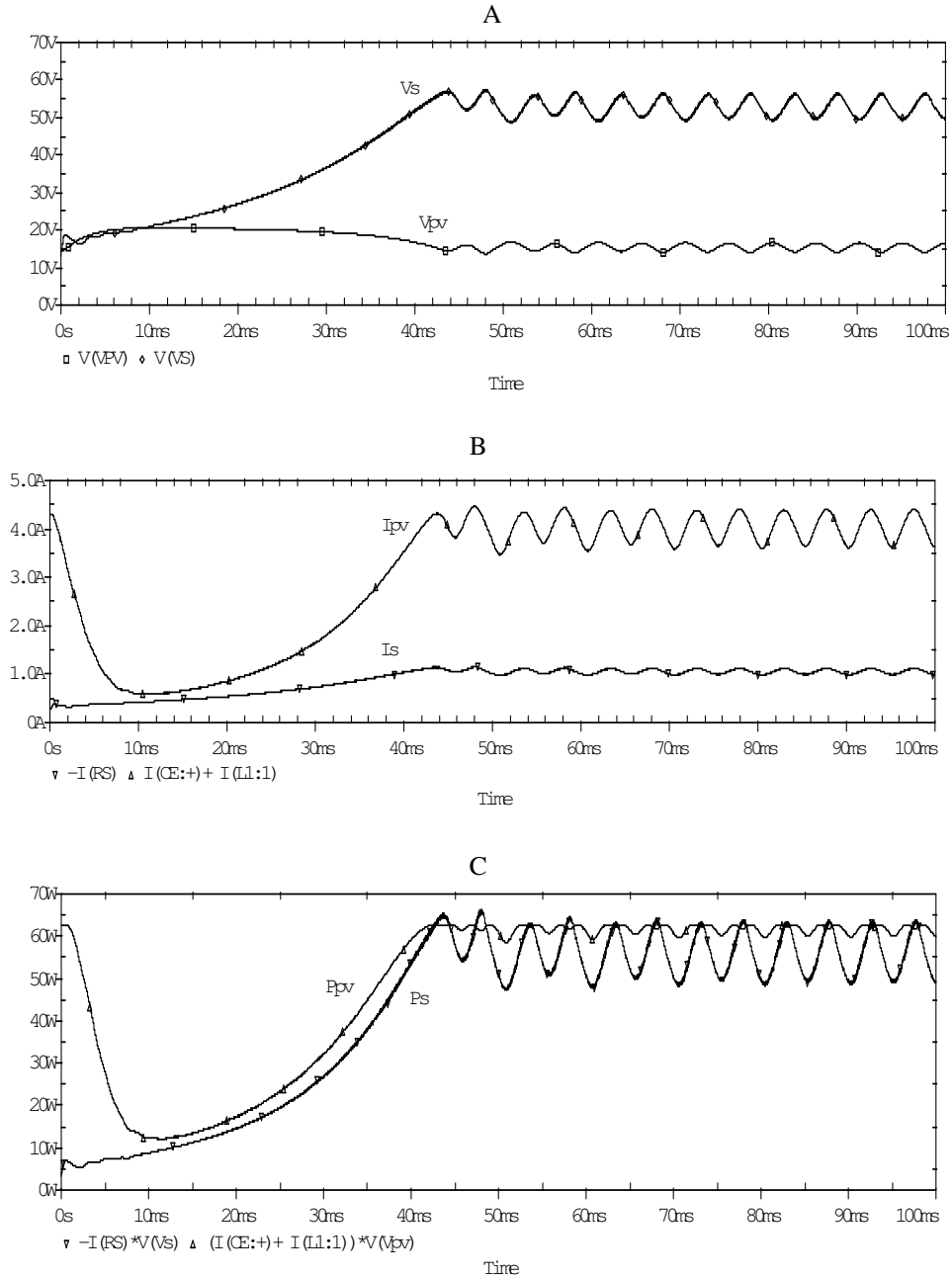

Figure 19. Simulation in Pspice of the electric quantities at the input and the output of the C-DC converter. $L_e=1000 \text{ W/m}^2$. $\tau_o: 4.7 \text{ k}\Omega * 10 \mu\text{F}= 47.0 \text{ ms}$. **A:** voltage, **B:** current, **C:** power.

- iii) Reverser amplifier (Block 3), which has as a role to change the sign of the difference.
- iv) The integrator (circuit RC) (Block 4), of time-constant τ_o , which has as a role to generate the reference voltage (V_{ref}).
- v) The comparator (Block 5), which compares the V_{ref} voltage with that provided by the oscillator (Block 6). This block generates a signal, modulated in width of impulse of period T, frequency of 10 kHz and duty cycle α . This

signal is injected to MOSFET transistor of the DC-DC converter through the driver. If this V_{ref} voltage increases the point of operation of PV generator (decreases) moves towards the conditions of the short-circuit (open circuit).

Operation of PV system in Pspice

On Figure 19, we have represented the various electric quantities (voltage, currents and powers) at the input and

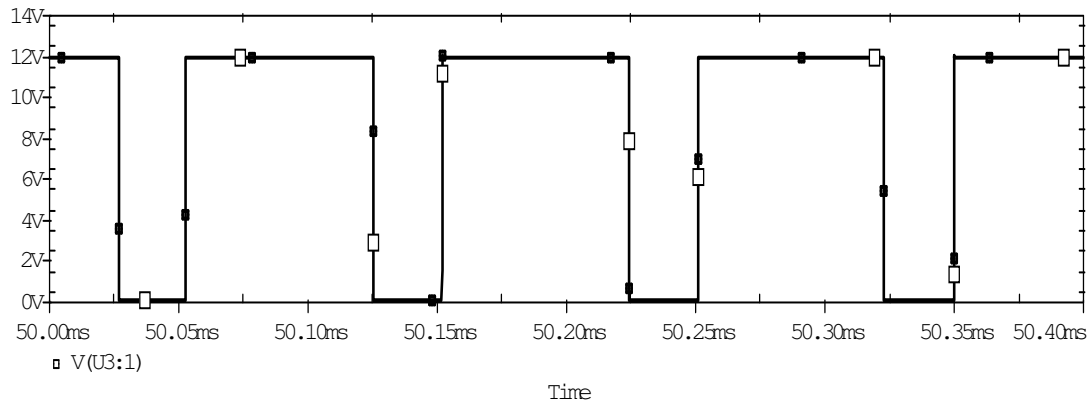

Figure 20. Simulation in Pspice of the signal on the output of comparator.

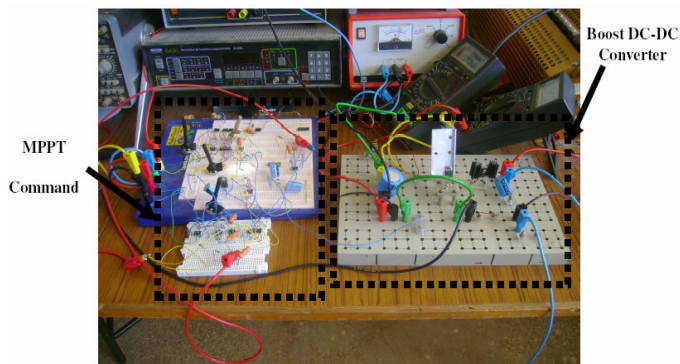

Figure 21. Photograph of the DC-DC Boost converter and MPPT command (CFV).

the output of the DC-DC converter (Figure 17), by taking account of the MPPT command CFV. The various parameters of this command are calculated to control the voltage on the output of PV generator to the value 15 V. The results obtained show that:

1. The system converges towards the optimal conditions about 40 ms.
2. The various electric quantities oscillate around their optimal values:
 - i) The input voltage (output) of the converter oscillates around 15 V (55 V),
 - ii) The input current (output) of the DC-DC converter oscillates around 4.13 A (1.1 A),
 - iii) The input power (output) of the converter oscillates around 64 W (62 W).

To make sure of the convergence of the system around the optimal conditions, we traced on Figure 20 the simulation of the signal generated by the comparator (Block 5). It appears that the frequency of this signal is of 10 kHz and his duty cycle is around of 0.72. This last value is in very good agreement with that obtained during

the analysis of the optimal operation of the boost converter. This shows well the optimal operation of PV system. Therefore, MPPT command used, control well the electric operation of PV generator around the optimal conditions. The oscillations obtained, strongly depend of the time constant τ : when τ increases (decreases), the system becomes slow (fast) and the amplitude of the oscillations decreases (increases).

Realization and characterization of PV system

Experimental procedure:

PV panels SP75 and the measuring equipments developed are those represented on Figures 12 and 13. The various blocks of the system (DC-DC Boost converter, MPPT Command) were realised on test circuit boards of Figure 21.

Electrical characterisation of complete PV system:

In order to validate the operation of PV system of Figure 18, we have followed the operation of this system, functioning during a day, as a function of the time-constant τ of the integrator (Block 4) and of the V_{pvo} voltage. From the obtained results, we have checked that the time-constant τ does not have a significant influence on the optimal electric quantities of PV panel.

Concerning the influence of the V_{pvo} voltage, we have represented on Figures 22 to 29 the variation of solar radiation and for 4 V_{pvo} voltage (16.5 V, 16 V, 15.54 V and 15 V) the variations of the duty cycle of the signal which control the switch of the DC-DC converter and the electric quantities at the input and the output of the DC-DC converter (currents, voltage and powers). It should be noted that during the measurements, the temperature with amber was, on one hand in order of 25°C at the beginning and the end of the day and on the other hand increases by 6 to 10°C in the middle of the day.

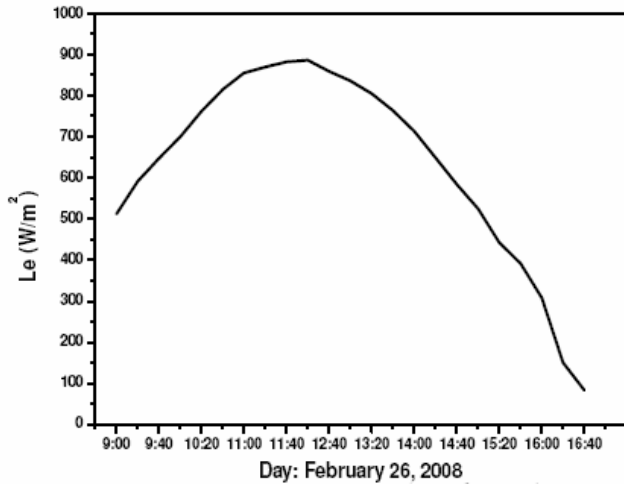

Figure 22. Variation of the solar radiation during the day February 26, 2008.

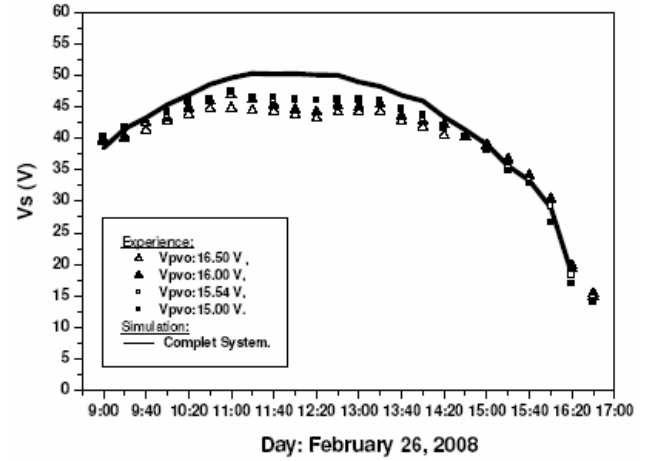

Figure 25. Variation of the Vs voltage on the output of the DC-DC converter during the day February 26, 2008.

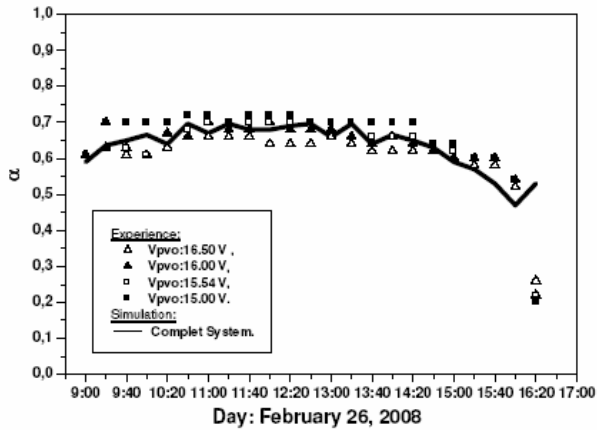

Figure 23. Variation of the duty cycle of PV system during the day February 26, 2008.

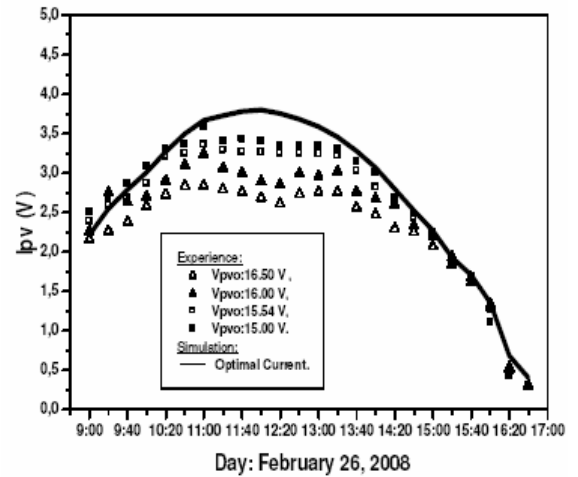

Figure 26. Variation of the Ipv current of PV panel during the day February 26, 2008.

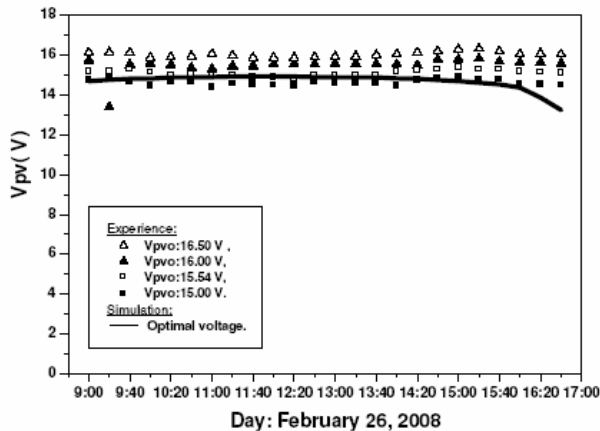

Figure 24. Variation of the Vpv voltage of the PV panel during the day February 26, 2008.

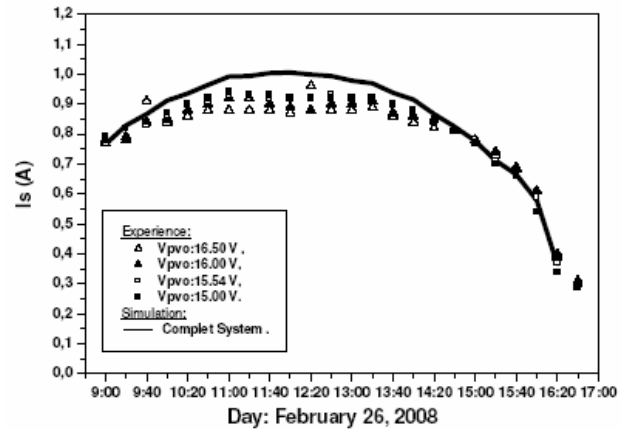

Figure 27. Variation of the Is current on the output of the DC-DC converter during the day February 26, 2008.

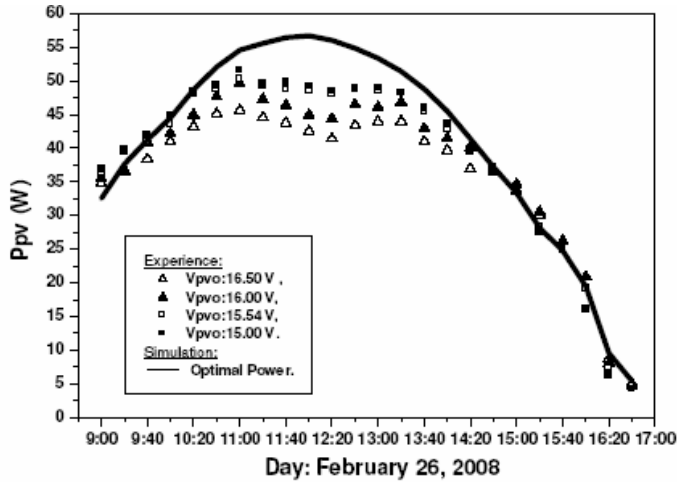

Figure 28. Variation of the power of PV panel during the day February 26, 2008.

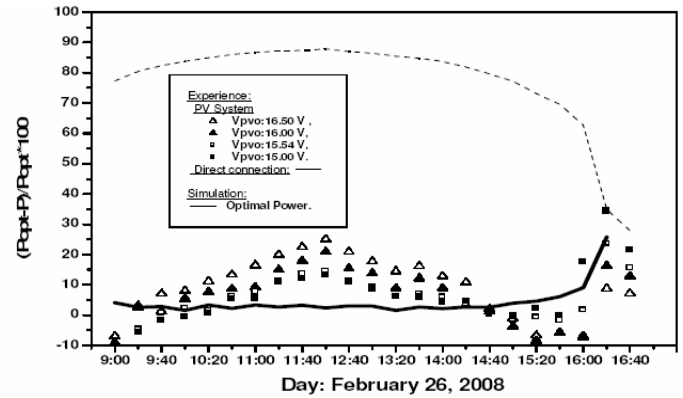

Figure 30. Losses of the power of PV panel of the PV system during the day February 26, 2008.

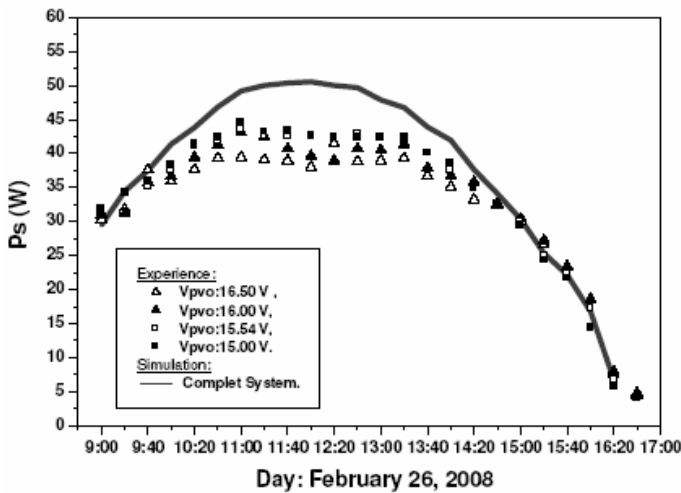

Figure 29. Variation of the power P_s on the output of the DC-DC converter during the day February 26, 2008.

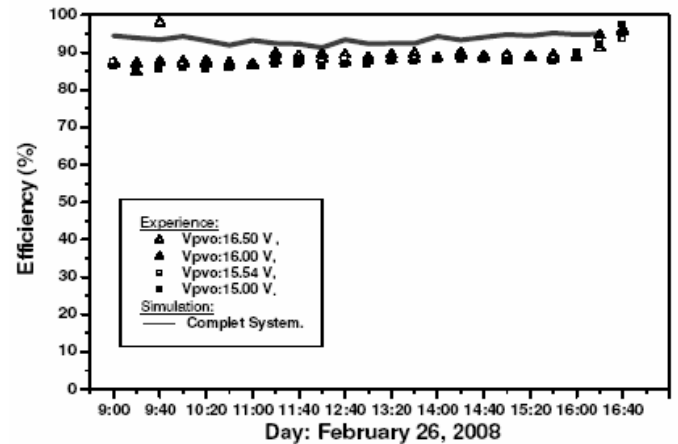

Figure 31. Efficiency of the DC-DC converter during the day February 26, 2008.

On the same Figures 23 to 29, we have represented the various optimal quantities, determined from the solar radiation of the Figure 22, by setting the temperature of to 25°C. The various results show that:

- i) At the beginning and the end of the day, the V_{pvo} voltage influence very little on the various electric quantities. These later are very close to optimal one.
- ii) In the middle of the day, the various electric quantities depend on the V_{pvo} voltage and are lower than those optimal quantities (given at 25°C). As shown in the Figure 30, the losses of powers can reach 25%. On the same Figure 30 we have represented the losses of power provided by PV panel when this one is directly connected to the load. It appears that MPPT command improves operation of PV panels. Under the conditions of our

experimentation the improvements can reach 80%.

To make sure of the good performance of the DC-DC converter, we have represented on Figure 31 the experimental efficiency of the DC-DC converter. On the same Figure, we have traced the efficiency simulated in Pspice. It appears that the efficiencies is very satisfactory (around 89%) and close to the simulated one. These results show well, the good performance of the DC-DC converter dimensioned and realized during this work.

In order to better interpret the results obtained, we have followed the operation of the system as a function of the V_{pvo} voltage when those are lower than 15 V. The results obtained are similar to those obtained when the V_{pvo} voltage is higher than 15 V, in particular in the middle of the day when the electric power provided by the PV panel is lower than the optimal. We have shown in Pspice that the voltage and the optimum power of PV panel are degraded with the temperature. Therefore, the increase of the temperature observed in the middle of the day can degrade the power provided by the PV panel. In

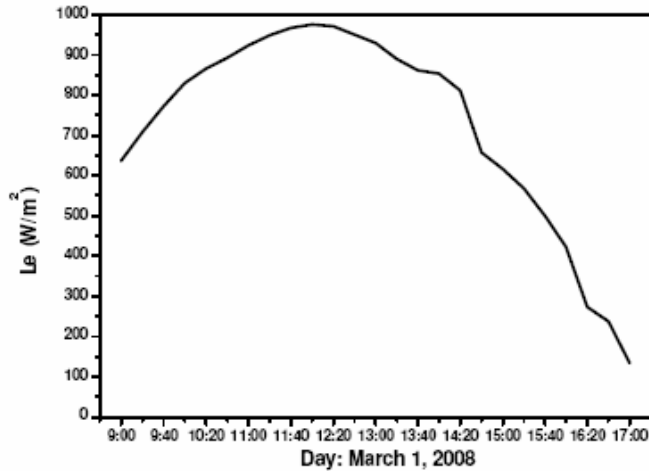

Figure 32. Variation of the solar radiation during the day March 1, 2008.

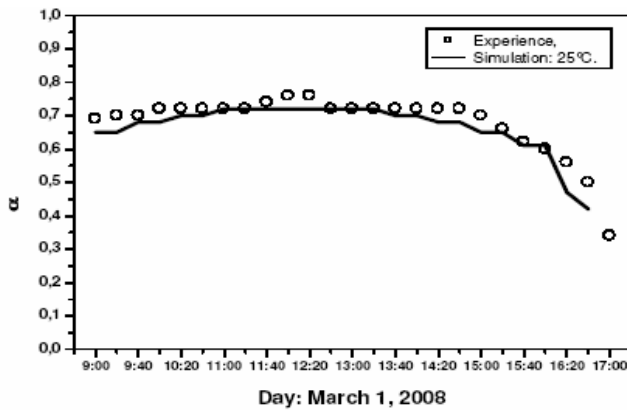

Figure 33. Variation of the duty cycle of PV system during the day March 1, 2008.

order to analyze thoroughly this last behavior, we model in the following paragraph, the behavior of the power provided by the PV panel as a function of the temperature, during sunny day.

Fine modeling of electrical quantities of PV system in Pspice:

In order to explain the losses of power provided by PV panels in the middle of the day, we have modelled from Pspice simulator, the PV system electric characteristics (voltage, current, power,...) during one day of function. On Figures 32 to 34 are represented the experimental results concerning solar radiation, the duty cycle α and power provided by the PV panel when the V_{pvo} voltage of MPPT command is around 15 V. On the same Figures 33 and 34 we have reported the simulated results in Pspice at ambient temperature (25°C). The obtained results show:

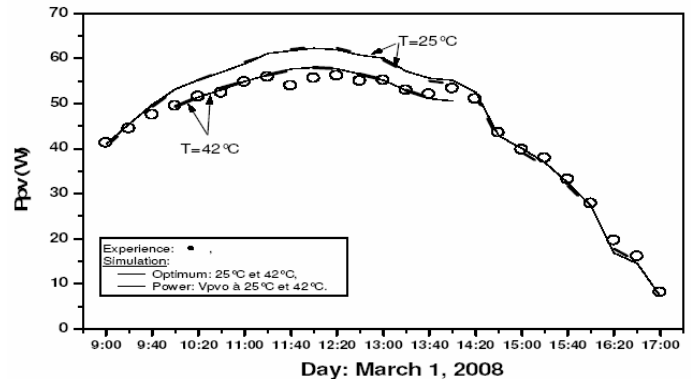

Figure 34. Power experimental and simulated in Pspice of PV panel during the day March 1, 2008.

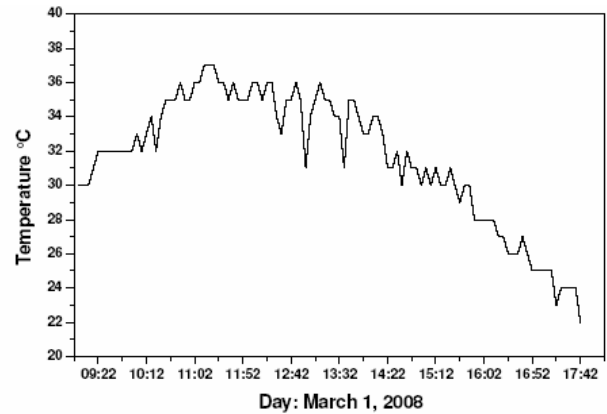

Figure 35. Variation in the temperature during the day March 1, 2008.

- i) MPPT command controls well the operation of PV panel.
- ii) At the beginning and the end of the day the power provided by the panel is practically that optimal with 25°C.
- iii) In the middle of the day, practically 5 to 8 W were lost (either 10%).

To interpret the behavior obtained in the middle of the day, we have measured the temperature close to the panel during all the day of PV system experiment (Figure 35). It appears that at the beginning and at the end of the day the temperature is around 25°C and it can reach 39°C in the middle of the day. Therefore, in the middle of the day the temperature can increase by 10 to 15°C compared to the beginning and the end of the day. In the theoretical part, we have shown that the increase in the temperature of 20°C can degrade the optimum voltage and power from 8 to 10%. Within the framework of our experimentation, the MPPT command controls the voltage of the PV panel to a fixed value which is of 15 V.

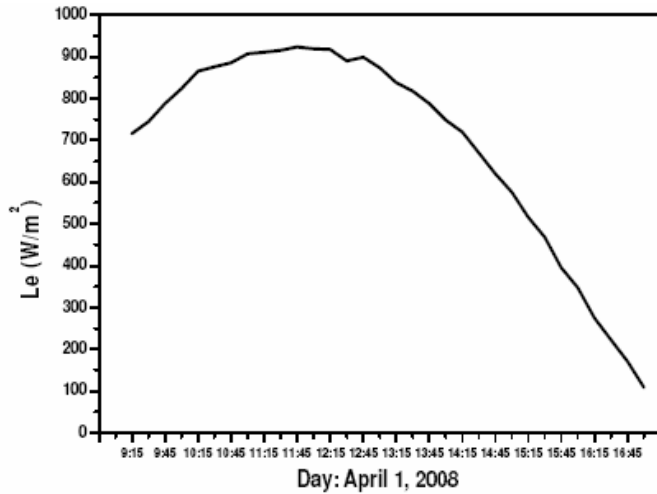

Figure 36. Variation of the solar radiation during the day April 1, 2008.

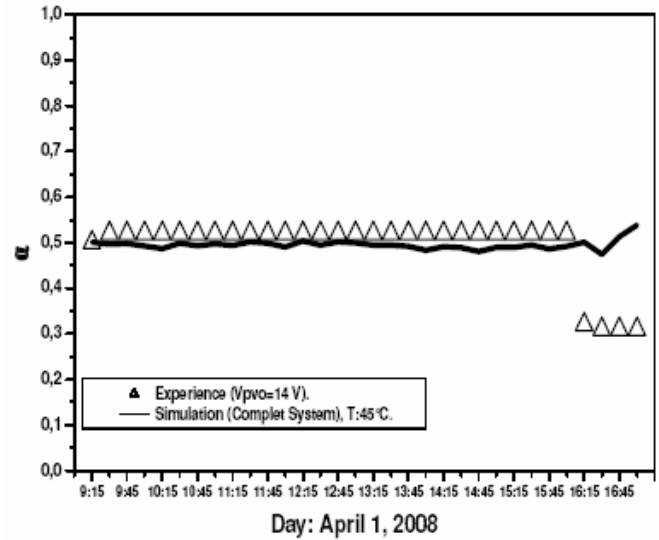

Figure 38. Variation of the duty cycle of PV system during the day April 1, 2008.

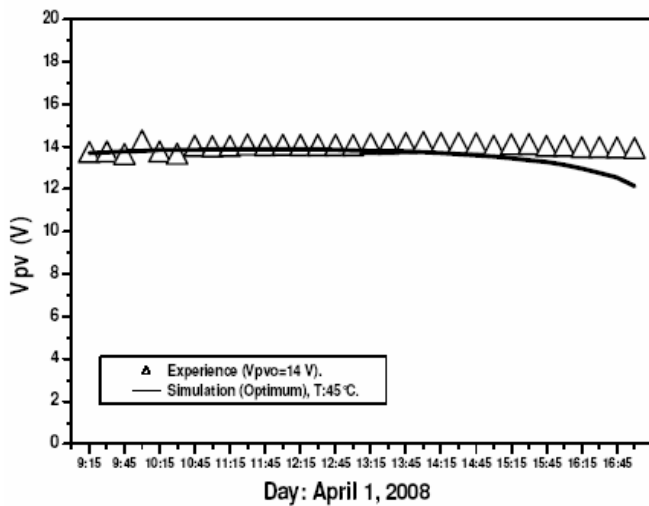

Figure 37. Voltage and simulated (optimal) in Pspice of PV panel during the day April 1, 2008

To take account of the increase of the temperature, it would be necessary that the V_{pvo} voltage decreases to 13.5 V. Therefore, the losses of powers are due to the fact that the V_{pvo} voltage is maintained at a fixed value. The simulation results show well that this can induce 8% of losses of powers.

In our case ($V_{pvo} = 15 \text{ V}$), we have traced on Figure 34, the powers simulated in Ppsice taking account of the increase in the temperature in the middle of the day. It appears that the temperature 42°C allows a very good agreement between the experiment and simulation. Also, the temperature value is in agreement with that measured close to the panel. Therefore, the degradation of the electric power provided by PV panel in the middle of the day is due to the increase in the temperature which

degrades the optimal electric quantities of the PV panel (voltage and power).

Also, the powers lost in the middle of the day can be due to the V_{pvo} voltage which is maintained constant with this high temperature. Within the framework of our experiment and according to the simulation results, when the temperature is around 42°C and the V_{pvo} voltage around of the 15V, the losses of powers by fixing this V_{pvo} voltage are lower than 2%. Therefore, the losses of powers are mainly due to the increase in the temperature.

Optimization of MPPT command (CFV):

In the preceding paragraphs we have shown that the optimal voltage of the PV panel decreases with the temperature. Since in the middle of the day the temperature of the PV panel increases considerably, the voltage undergoes an important decrease temperature, when the temperature varies 25 to 42°C , the optimal voltage varies from 15 to 14 V. From the measurements temperature, which are taken around the PV panel in April, we have deduced that the temperature is 25°C at the beginning and the end of the day and 42°C in the middle of the day. Since at the beginning and the end of the day the temperature does not have an influence on the choice of the V_{pvo} voltage, then we can fix this voltage at the value which corresponds to the temperature 42°C of the middle of the day ($V_{pvo} = 14 \text{ V}$).

On Figures 36 to 39 are represented the experimental results concerning solar radiation, the V_{pv} voltage of the PV panel, the duty cycle α and power provided by the PV panel. On the same Figures we have traced the optimal electrical characteristics at the ambient temperature (42°C). On Figure 40 we have deduced and represented

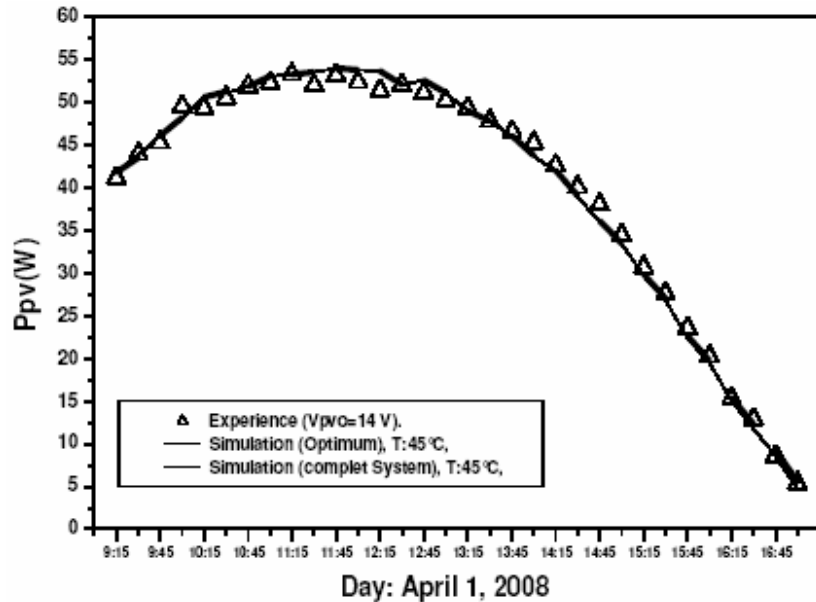

Figure 39. Power experimental and simulated in Pspice of PV panel during the day April 1, 2008.

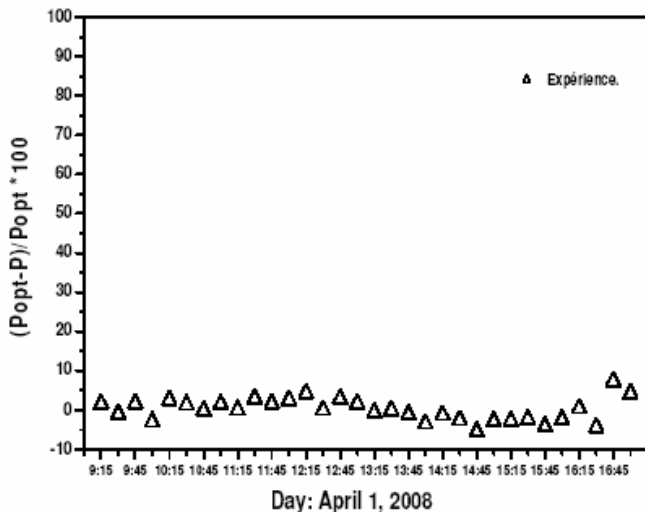

Figure 40. Power losses of the PV panel during the day April 1, 2008.

the losses of powers compared to the optimal situations. The whole of the results obtained show:

- i) MPPT command controls well the operation of PV panel.
- ii) A good agreement between the experiment and simulation during all the day of the operation of the PV system.
- iii) The electrical energy provided by the panel is in the order of 300 Wh.
- iv) The losses of instantaneous power are weak (lower than 2%).

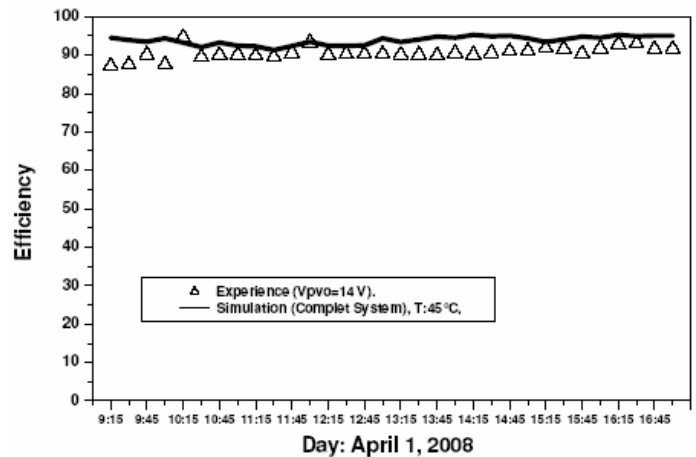

Figure 41. Efficiency of the DC-DC converter during the day April 1, 2008.

To make sure of the good performance of the DC-DC converter, we have represented on Figure 41 the experimental efficiencies and those simulated in Pspice. It appears on one hand very satisfactory efficiencies (order of 90%) and on the other hand a good agreement between the experiment and simulation. The whole of the results show that MPPT command CFV controls well the operation of the PV panels. The V_{pvo} voltage set by the command must be selected with precaution by taking account into the increase in the temperature. In the PV installations, it would be necessary to set the voltage which corresponds to the temperature of the middle of the day.

Conclusion

In this article, we have analyzed in the Pspice simulator the influence of the temperature on the optimal operation of the photovoltaic (PV) panels (SP 75) and on the operation of the photovoltaic PV system. The electric power provided by the PV panel is controlled by an MPPT command which controls the Vpvo voltage of PV panel to a fixed value (CFV).

We have shown that the optimum voltage and the power of the PV panels depend on the temperature. When the temperature increases (decreases) by 20°C compared to the ambient temperature (25°C), the optimum voltage or the power decreases (increases) by 8%. These results show that when the operation of the PV panel is controlled by an MPPT command CFV, the Vpvo voltage must be set with precaution as a function of the temperature of the seasons.

In order to validate the whole of the results obtained, we have realized and analyzed the operation of a PV system. We have analyzed the operation of the system during several sunny days as a function of the Vpvo voltage. We showed that during days when the temperature can exceed 40°C, in the middle of the day, the PV panels can undergo losses of powers around of the order from 20 to 25% when that one fixes the Vpvo voltage which corresponds to that of the ambient temperature. Also, at the beginning and the end of the day when the temperature is around in the order of 25°C, the losses of PV panels is very weak (lower than 2%) if one fixes the Vpvo voltage which corresponds to that of a high temperature.

During one day when the temperature in the middle of the day is around in the order of 42°C, we have set the Vpvo voltage which corresponds to this temperature and followed the operation of this system during this day. We have shown that the losses of instantaneous power provided by PV panel are very weak (lower than 2%) during all the day. These results on one hand confirm those obtained in the Ppsice simulator and on the other hand enabled us to propose an optimal functioning of the PV systems which uses MPPT command CFV. For this type of MPPT command, it is recommended to fix the Vpvo voltage which corresponds to that of the temperature of the middle of the day.

The whole of the results obtained in this work shows that designed (PV) system, simulated and realized in this work can be used in a PV installation in order to optimize the functioning of PV generators.

ACKNOWLEDGMENTS

This work is supported by:

- i) Programme Thématique d'Appui à la Recherche Scientifique (PROTARS III) 'D43/06,
- ii) Coopération Maroc-Belge « Commission Universitaire

Institutionnelle», CUI-Oujda 2008-2012 (Activité Eau et Environnement / sous-activité Energies Renouvelables),
 iii) du programme Global de Recherche de l'Université Mohammed Premier d'Oujda, PGR.

REFERENCES

- Al-Atrash H, Batarseh I, Rustom K (2005). Statistical modeling of DSP-Based hill-climbing MPPT algorithms in noisy environments Applied Power Electronics Conference and Exposition, 2005. APEC 2005, Twentieth Annual IEEE, 3: 6-10. pp. 1773-1777.
- Bahgat ABG, Helwa NH, Ahmad GE, El Shenawy ET (2005). Maximum power point tracking controller for PV systems using neural networks, Renewable Energy 30: 1257-1268.
- Esrasm T, Jonathan WK, Philip TK, Patrick LC, Pallab M (2006). 'Dynamic Maximum Power Point Tracking of Photovoltaic Arrays Using Ripple Correlation Control', IEEE TRANSACTIONS ON POWER ELECTRONICS, 21: 9-5.
- Femia N, Petrone G, Spagnuolo G, Vitelli M (2004) "Optimizing duty-cycle perturbation of P&O MPPT technique" Power Electronics Specialists Conference, 2004. PESC 04. 2004 IEEE 35th Annual. 3: 20-25 June 2004 Pages: 3: 1939-1944.
- Gruber DP, Meinhardt G, Papousek W (2005). Spatial distribution of light absorption in organic photovoltaic devices. Solar Energy 79(6): 697-704.
- Gules R, Juliano De Pellegrin P, Hélio LH, Johninon I (2008). 'Maximum Power Point Tracking System With Parallel Connection for PV Stand-Alone Applications', IEEE TRANSACTIONS ON INDUSTRIAL ELECTRONICS, 55: 7- 7.
- Jain S, Agarwal V (2004). 'A New Algorithm for Rapid Tracking of Approximate Maximum Power Point in Photovoltaic Systems', IEEE POWER ELECTRONICS LETTERS, 2: 3-1.
- Kassmi K, Hamdaoui M, Olivé F (2007). « Caractérisation des panneaux photovoltaïques, Conception et optimisation d'un système photovoltaïque pour une meilleure exploitation de l'énergie solaire », Energies Renouvelables, Organisation des Nations Unies pour l'Education, la Science et la culture, Bureau de l'UNESCO à Rabat, Bureau Multi pays pour le Maghreb, Les énergies renouvelables au Maroc, Le débat est lancé. ISBN9954_8068_2_2, pp. 87-110, 2007, Rabat, Morocco.
- Mohamed Firas SHRAIF (2002). 'Optimisation et mesure de chaîne de conversion d'énergie photovoltaïque en énergie électrique', Doctorat de l'Université Paul Sabatier de Toulouse (France), Année
- Mrabti T, Ouariachi MEL, Kassmi K, Kassmi KA, Bagui F (2009). 'Regulation of the electric power of the photovoltaic generators with DC-DC converter (Buck type) and MPPT command, International Conference on Multimedia Computing and Systems. ICMCS'09 IEEE ISBN: 978-1-4244-3757-3 - April 02-04, 2009 - Ouarzazate, Morocco.
- Mrabti T, Ouariachi MEL, Kassmi K, Olivé F, BAGUI F (2008). « Amélioration du fonctionnement des systèmes photovoltaïques suite aux brusques variations des conditions météorologiques et de la charge », Revue des Energies renouvelables CDER, ISSN : 1112-2242 - Dépôt Légal : 1177-98, 11 : 1107-117.
- Salameh Z, Taylor D (1990). step-up maximum power point tracker for photovoltaic arrays', solar Energy 44 (1): 57-61.
- Salameh ZM, Dagher F, Lynch WA (1991). 'Step-down Maximum Power Point Tracker for Photovoltaic Systems, Solar Energy, 46(5): 279-282.
- Sze SM (1981). Physics of semiconductors Devices, J. Wiley New York.
- Taftcht T, Agbossou K, Doumbia ML, Chériti A (2008). " An improved maximum power point tracking method for photovoltaic systems", Renewable Energy 33: 1508-1516.
- Theodoros L, Kottas SB, Yiannis S, Boutalis DK, Athanassios DK (2006). IEEE Transactions on Energy Conversion 21: 9-3.
- Woyte A, Vu Van T, IEEE, Ronnie B, Johan N (2006). 'Voltage Fluctuations on Distribution Level Introduced by Photovoltaic Systems'. IEEE Transactions on Energy Conversion, Vol. 21, No. 1,

March 2006

Yu GJ, Jung YS, Choi JY, Kim V (2004). "A novel tow-mode MPPT control algorithm based on comparative study of existing algorithms", Solar Energy 76: 455-463.